



NOUVELLES FERMETURES INTERNATIONAL  
2012-2022

# EXTENSION DE MAISON

HOUSE  
EXTENSION



FR|EN\_V2\_24/10\_2022





**003**  
**PERGOLA**  
PERGOLA

**005 Pergola Polycarbonate**  
Pergola Polycarbonate

**013 Pergola Toile**  
Pergola Shade Cloth

**021 Pergola Bioclimatique**  
Pergola Bioclimatic

**033 Store Vertical**  
Vertical Blind

**035 Store Vertical Zip**  
Vertical Blind Zip

**037 Rideau de Verre**  
Glass Curtain

**039 Cloison de claire voie**  
Privacy Screen

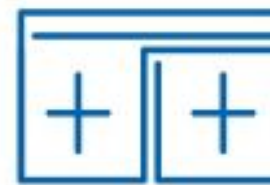

**041**  
**VERANDA**  
GLASS ROOM

**043 Veranda**  
Glass room

**047 Jardin d'Hiver Contemporain**  
Winter Garden Contemporain

**049 Jardin d'Hiver Classic**  
Winter Garden Classic



**051**  
**STORE-BANNE**  
AWNING

# SOMMAIRE

## INDEX

---





# PERGOLA

# PERGOLA

**005 Pergola Polycarbonate**  
Pergola Polycarbonate

**013 Pergola Toile**  
Pergola Shade Cloth

**021 Pergola Bioclimatique**  
Pergola Bioclimatic

**033 Store Vertical**  
Vertical Blind

**035 Store Vertical Zip**  
Vertical Blind Zip

**037 Rideau de Verre**  
Glass Curtain

**039 Cloison de claire voie**  
Privacy Screen

005

PERGOLA | PERGOLA

**NF** **WISMAAT-NF**  
EDITION VERTRIEBSGESELLSCHAFT



P. POLYCARBONATE  
P. POLYCARBONATE

# SUNDAY

## Caractéristiques | Characteristics

- Poteau et faitière 120x64mm
- Gouttière 93x141mm
- Chevron 80x40mm
- Aluminium thermolaqué Qualicoat / Qualimarine / Qualanod
- Polycarbonate translucide 16mm traité anti UV avec obturateur poly, adhésif microperforé, en option polycarbonate 32mm
- Platine de fixation au sol
- Vis de fixation fournies
- Bouchon de recuperation des eaux de pluie inclus
- Posts and beams 120x64mm
- Rain gutter 93x141mm
- Rafters 80x40mm
- Powder coated aluminum Qualicoat / Qualimarine / Qualanod
- Polycarbonate translucent 16mm treated anti UV with poly shutter, adhesive microperforated, as optional 32mm
- Floor mounting plate
- Fixing screws provided
- Rainwater recovery cap included

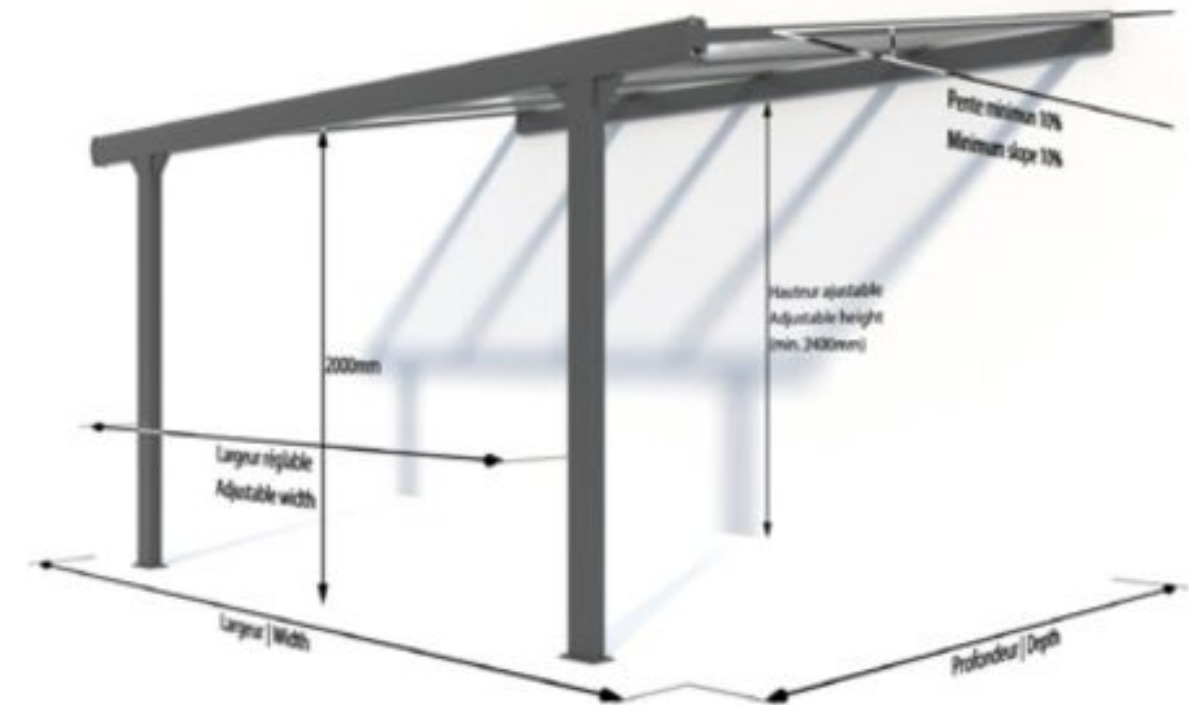

**Résistance au VENT**  
Resistance to WIND

C6

Certifié ENAC - Laboratoire ENSATEC -  
 CE NB 1668 n° de organisme notifié  
 Classement - VENT C6  
 EN 13561  
 Certified ENAC - Laboratory ENSATEC -  
 CE NB 1668 notified entity number  
 Ranking - WIND C6  
 EN 13561

**Chevron d'extrémité**  
End Rafters



**Chevron intermédiaire**  
Middle Rafters



**Gouttière**  
Rain Gutter



**Poteau**  
Post



**Platine au sol**  
Floor Plate







P. POLYCARBONATE  
P. POLYCARBONATE

## SUNVISOR

### Caractéristiques | Characteristics

- Possibilité de sur mesure
- Poteau et faitière 120x64mm
- Gouttière 93x141mm
- Chevron 80x40mm
- Aluminium thermolaqué Qualicoat / Qualimarine / Qualanod
- Polycarbonate translucide 16mm traité anti UV avec obturateur poly, adhésif microperforé
- Platine de fixation au sol
- Bouchon de recuperation des eaux de pluie inclus
- Custom possibility
- Posts and beams 120x64mm
- Gutter 93x141mm
- Rafters 80x40mm
- Powder coated aluminum Qualicoat / Qualimarine / Qualanod
- Polycarbonate translucent 16mm treated anti UV with poly shutter, adhesive microperforated
- Floor mounting plate
- Rainwater recovery cap included

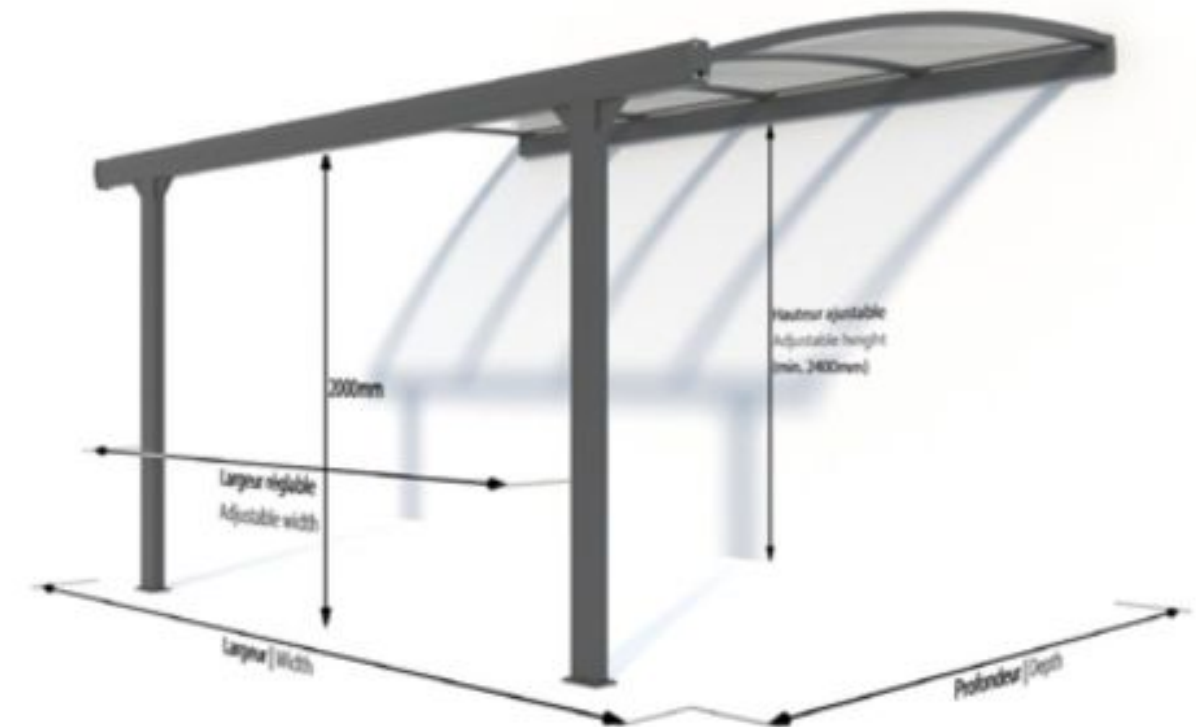
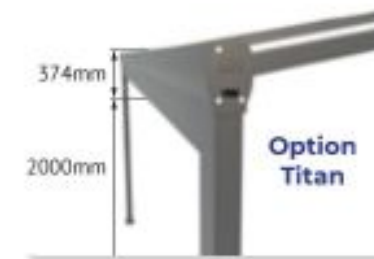

**Résistance au VENT**  
Resistance to WIND

C6

CE

Certifié ENAC - Laboratoire ENSATEC -  
CE NB 1668 n° de organisme notifié  
Classement - VENT C6  
EN 13561

Certified ENAC - Laboratory ENSATEC -  
CE NB 1668 notified entity number  
Ranking - WIND C6  
EN 13561

**Chevron d'extrémité**  
End Rafters



**Chevron intermédiaire**  
Middle Rafters



**Gouttière**  
Rain Gutter



**Poteau**  
Post



**Platine au sol**  
Floor Plate





P. POLYCARBONATE  
P. POLYCARBONATE

## SUNRISE DOUBLE PAN

### Caractéristiques | Characteristics

- Existe en adossé et autoportant
- Poteau 154x154mm
- Poutre gouttière 260x150mm
- Chevron 80x45mm
- Inclinaison cachée double pente
- Aluminium thermolaqué Qualicoat / Qualimarine / Qualanod
- Platine de fixation au sol
- Panneau de polycarbonate translucide 16mm traité anti UV avec obturateur poly, adhésif microperforé
- Available as lean to and freestanding
- Posts 154x154mm
- Gutter beam 260x150mm
- Rafters 80x45mm
- Hidden double slope
- Powder coated aluminum Qualicoat / Qualimarine / Qualanod
- Floor mounting plate
- Translucent polycarbonate panel 16mm treated anti UV with poly shutter, microperforated adhesive

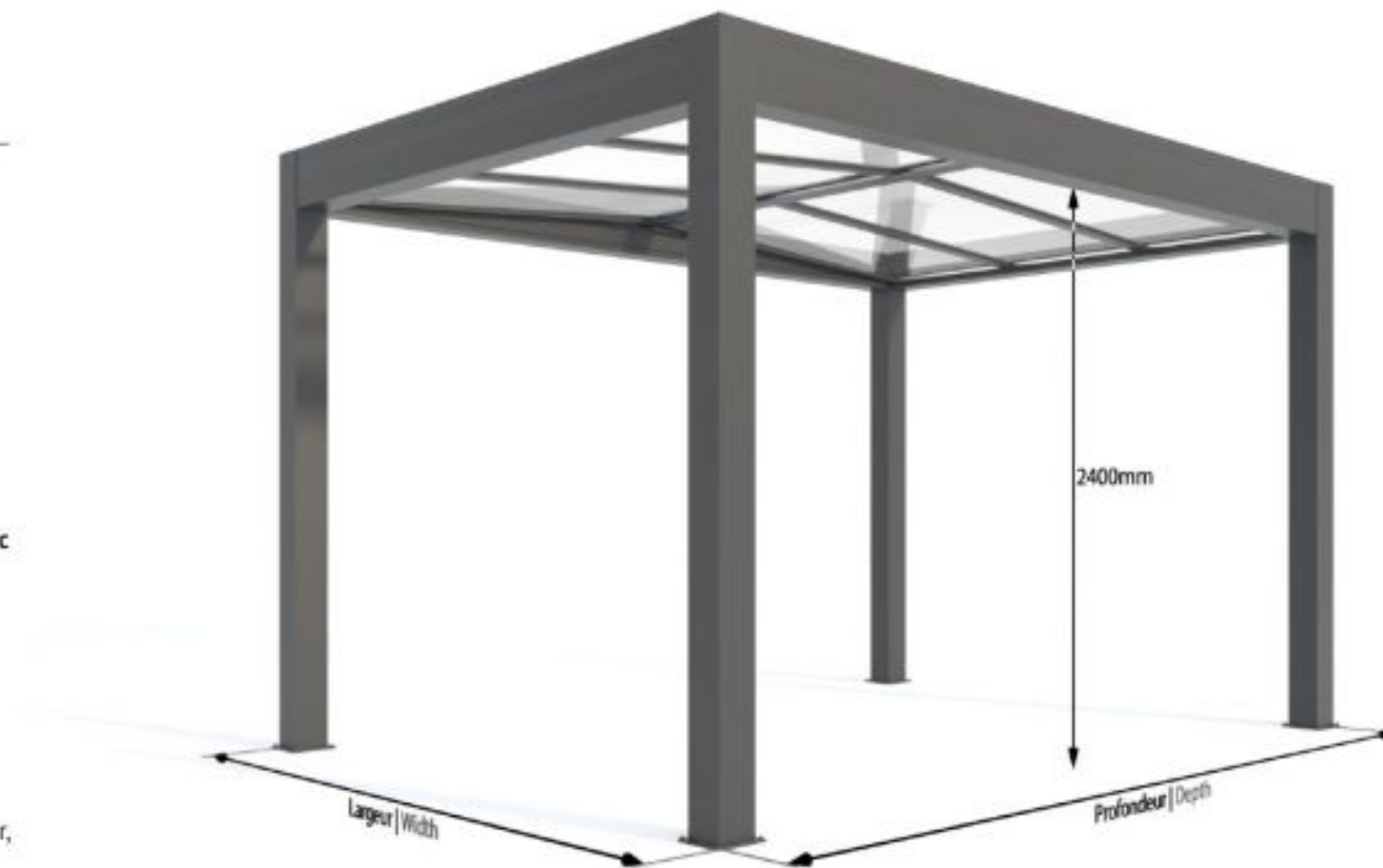

**Résistance au VENT**  
Resistance to WIND

**C5**

Certifié ENAC - Laboratoire ENSATEC -  
CE NB 1668 n° de organisme notifié  
Classement - VENT C5  
EN 13561

Certified ENAC - Laboratory ENSATEC -  
CE NB 1668 notified entity number  
Ranking - WIND C5  
EN 13561





P. POLYCARBONATE  
P. POLYCARBONATE

## SUNRISE MONO PAN

### Caractéristiques | Characteristics

- Existe en adossé seulement
- Poteau 100x100mm et Poutre gouttière 288x100mm ou 438x100mm
- Chevron 80x40mm
- Inclinaison cachée mono pente
- Aluminium thermolaqué Qualicoat / Qualimarine / Qualanod
- Platine de fixation au sol
- Panneau de polycarbonate translucide 16mm traité anti UV avec obturateur poly, adhesif microperforé
- Available only as lean to
- Posts 100x100mm and Gutter beam 288x100mm or 438x100mm
- Rafters 80x40mm
- Hidden one slope
- Powder coated aluminum Qualicoat / Qualimarine / Qualanod
- Floor mounting plate
- Translucent polycarbonate panel 16mm treated anti UV with poly shutter, microperforated adhesive

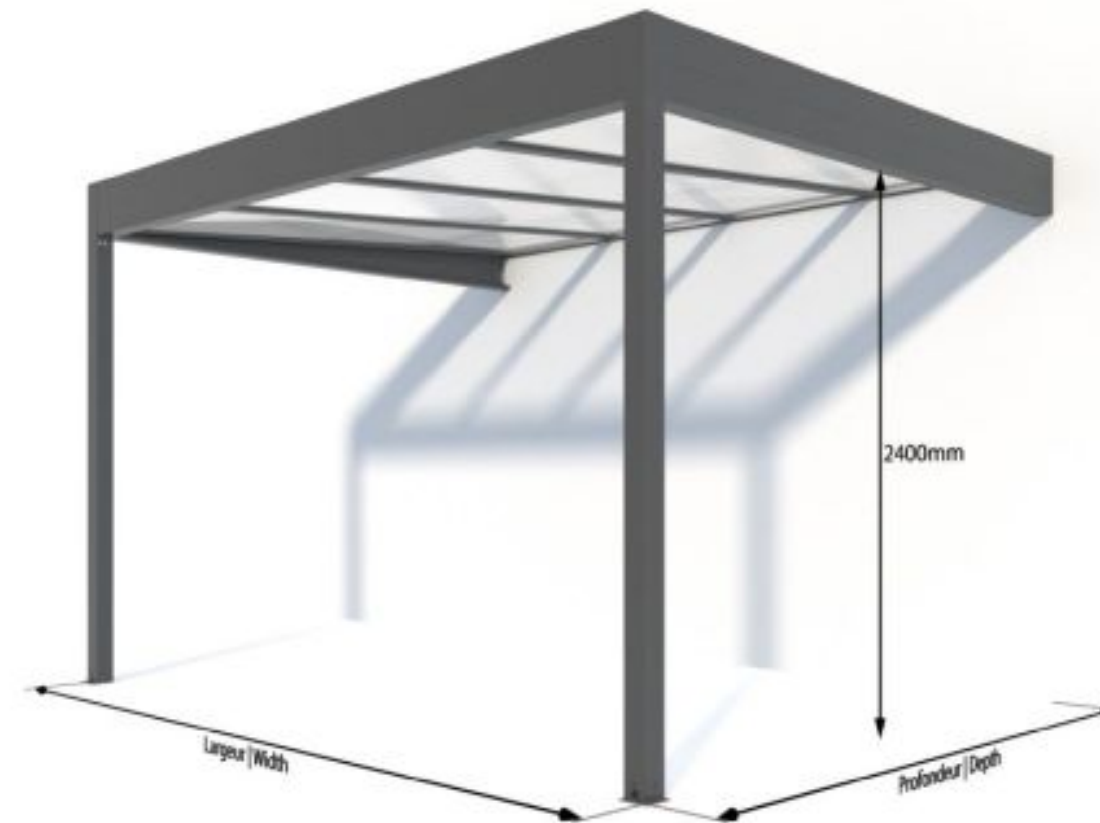

Poutre Gouttière  
Beam Rain Gutter

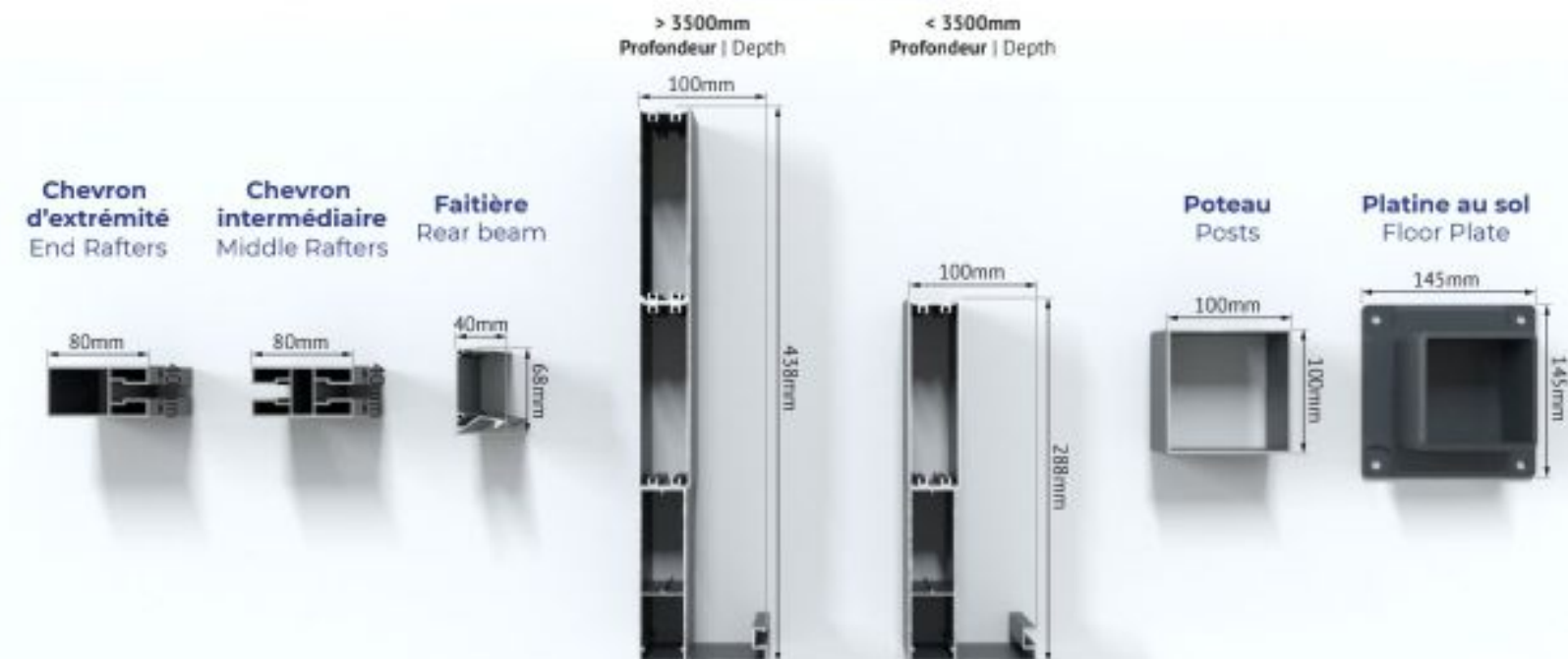

Résistance au VENT  
Resistance to WIND

C5



Certifié ENAC - Laboratoire ENSATEC -  
CE NB 1668 n° de organisme notifié  
Classement - VENT C5  
EN 13561

Certified ENAC - Laboratory ENSATEC -  
CE NB 1668 notified entity number  
Ranking - WIND C5  
EN 13561



**PERGOLA TOILE**  
 PERGOLA SHADE CLOTH  
**SUNSHINE**

**Caractéristiques | Characteristics**

- |  |   |
|--|---|
| - Poteau 100x100mm, Traverse 60x40mm                       | - Posts 100x100mm, beams 60x40mm                            |
| - Aluminium thermolaqué Qualicoat / Qualimarine / Qualanod | - Powder coated aluminum Qualicoat / Qualimarine / Qualanod |
| - Platine de fixation abs au sol                           | - ABS floor mounting plate                                  |
| - Toile polyester 230grs imperméabilisée                   | - Polyester cloth 230grs waterproof                         |

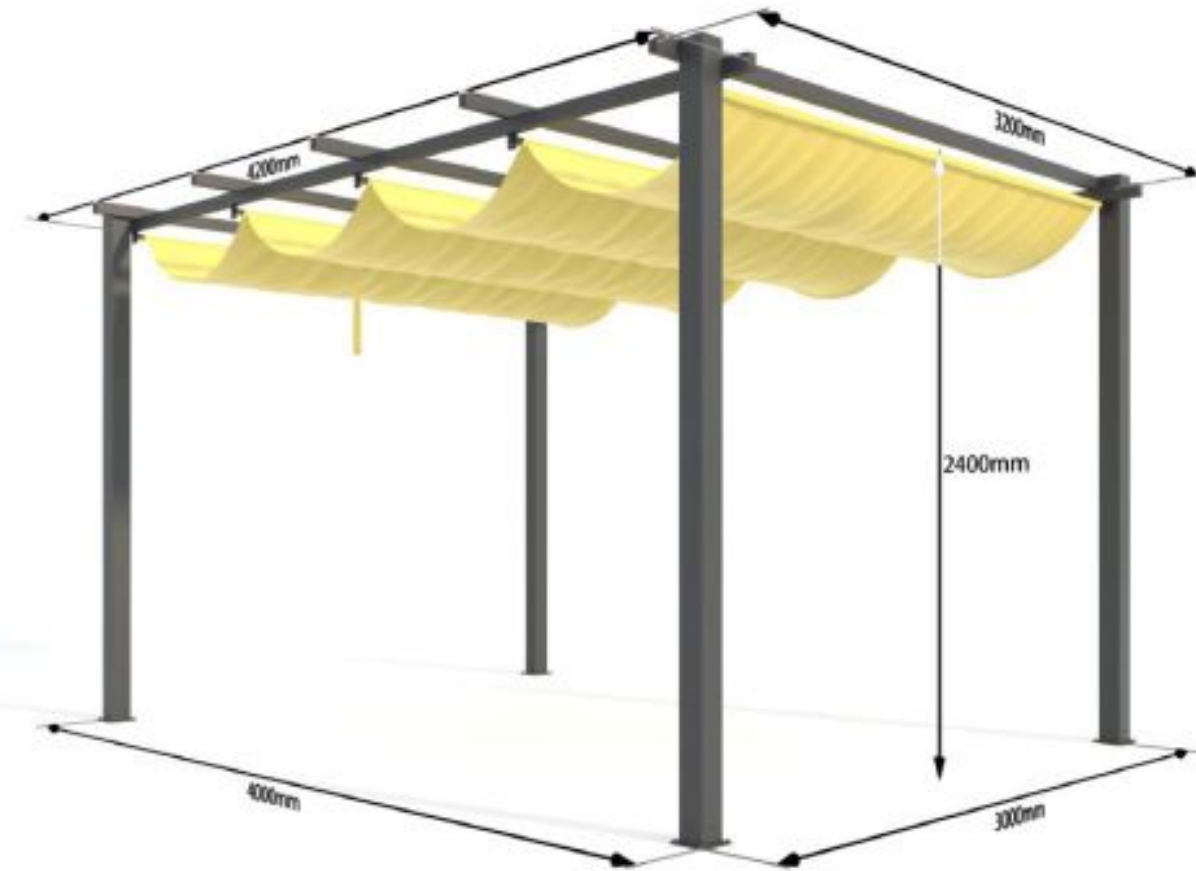

**Résistance au VENT**  
Resistance to WIND

**C3**



Certifié ENAC - Laboratoire ENSATEC -  
 CE NB 1668 n° de organisme notifié  
 Classement - VENT C3  
 EN 13561

Certified ENAC - Laboratory ENSATEC -  
 CE NB 1668 notified entity number  
 Ranking - WIND C3  
 EN 13561

**Traverse supérieure**  
Beam high



**Traverse inférieure**  
Beam low



**Poteau**  
Posts

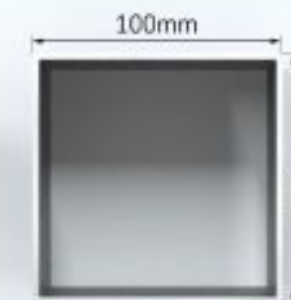

**Platine au sol**  
Floor Plate

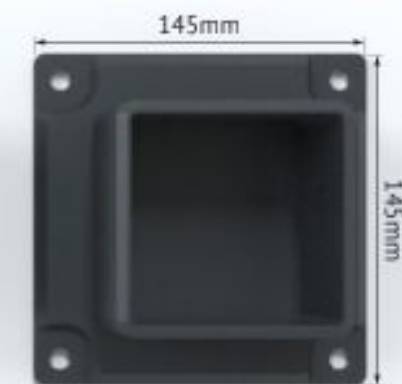





PERGOLA TOILE  
 PERGOLA SHADE CLOTH  
**SUNSET**

**Caractéristiques** | Characteristics

- Poteau 100x100mm et Poutre gouttière 137x100mm
  - Aluminium thermolaqué Qualicoat / Qualimarine / Qualanod
  - Platine de fixation abs au sol
  - Toile polyester 230grs imperméabilisée
- Posts 100x100mm and Gutter beam 137x100mm
  - Powder coated aluminum Qualicoat / Qualimarine / Qualanod
  - ABS floor mounting plate
  - Polyester cloth 230grs waterproof



RÉSISTANCE AU VENT  
 Resistance to WIND

C2

CE

Certifié ENAC - Laboratoire ENSATEC -  
 CE NB 1668 n° de organisme notifié  
 Classement - VENT C2  
 EN 13561

Certified ENAC - Laboratory ENSATEC -  
 CE NB 1668 notified entity number  
 Ranking - WIND C2  
 EN 13561

**Gouttière**  
 Rain gutter



**Poteau**  
 Posts



**Platine au sol**  
 Floor Plate

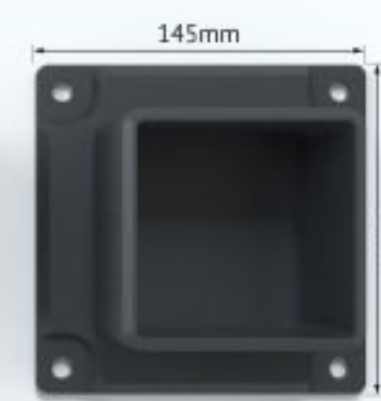



PERGOLA TOILE  
PERGOLA SHADE CLOTH  
**SUNLIGHT**

**Caractéristiques | Characteristics**

- |  |   |
|--|---|
| - Poteau 100x100mm et Poutre gouttière 137x100mm           | - Posts 100x100mm and Gutter beam 137x100mm                 |
| - Aluminium thermolaqué Qualicoat / Qualimarine / Qualanod | - Powder coated aluminum Qualicoat / Qualimarine / Qualanod |
| - Platine de fixation abs au sol                           | - ABS floor mounting plate                                  |
| - Toile polyester 230grs imperméabilisée                   | - Polyester cloth 230grs waterproof                         |

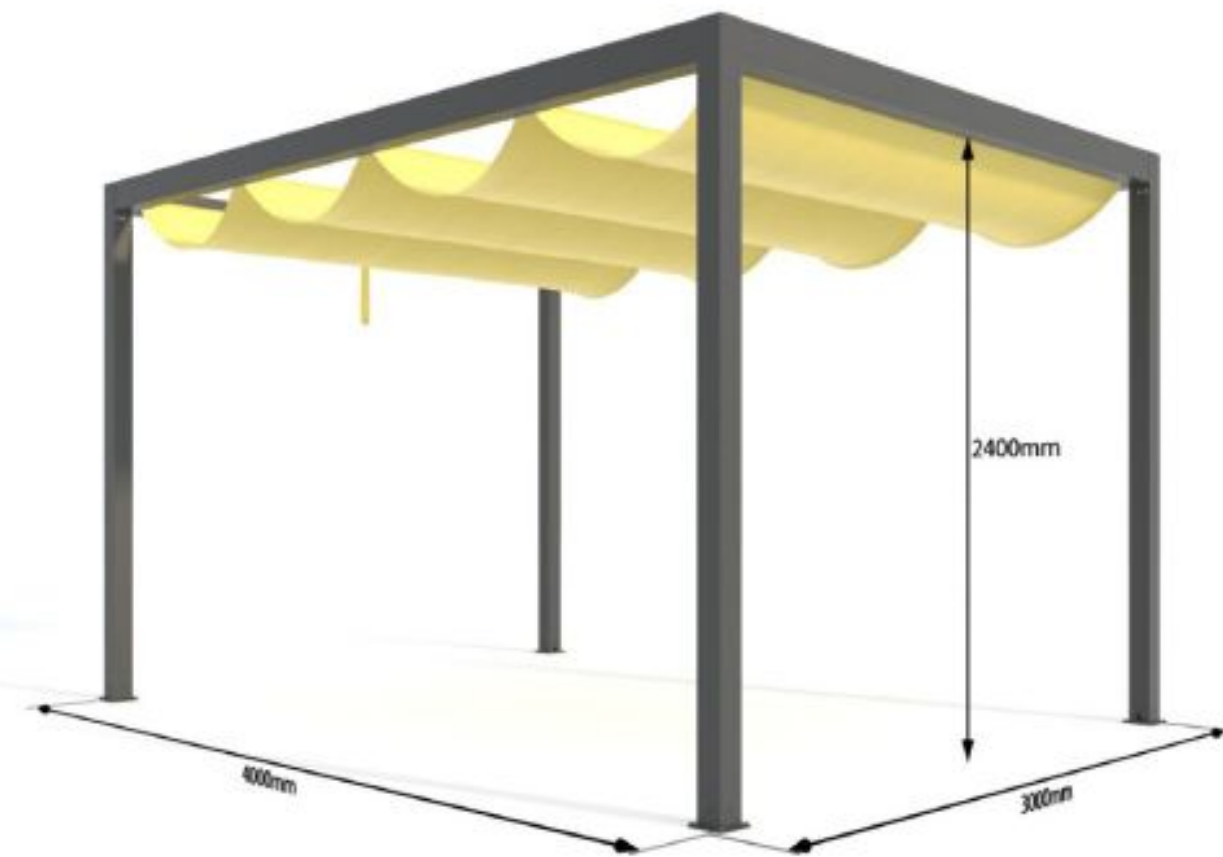

Résistance au VENT  
Resistance to WIND

**C3**



Certifié ENAC - Laboratoire ENSATEC -  
CE NB 1668 n° de organisme notifié  
Classement - VENT C3  
EN 13561

Certified ENAC - Laboratory ENSATEC -  
CE NB 1668 notified entity number  
Ranking - WIND C3  
EN 13561

**Gouttière**  
Rain gutter



**Poteau**  
Posts



**Platine au sol**  
Floor Plate





PERGOLA TOILE  
PERGOLA SHADE CLOTH

# SUNFLOWER

## Caractéristiques | Characteristics

- Montant: 90x90mm
  - Montant supérieur: 90x120mm
  - Coffre de la toile:
    - Largeur supérieure du coffre: 185mm
    - Largeur inférieure du coffre: 127mm
  - Montant de la toile: 112x48mm
  - Aluminium thermolaqué Qualicoat / Qualimarine / Qualanod
  - Toile acrylique teintée dans la masse 300g/m<sup>2</sup> pour des couleurs éclatantes et durables
  - Motorisation NFI et récepteur radio avec sa télécommande individuelle
  - Traitement imperméabilisant, double couture
  - Platine de fixation au sol
  - Vis de fixation fournies
- Post: 90x90mm
  - Upper lower: 90x120mm
  - Canvas box:
    - Upper box width: 185mm
    - Lower box width: 127mm
  - Amount of the canvas: 112x48mm
  - Qualicoat / Qualimarine / Qualanod thermo-lacquered aluminum
  - 300g/m<sup>2</sup> dyed acrylic canvas for vibrant and durable colors
  - NFI motor and radio receiver with individual remote control
  - Waterproofing treatment, double stitching
  - Floor mounting plate
  - Fixing screws provided

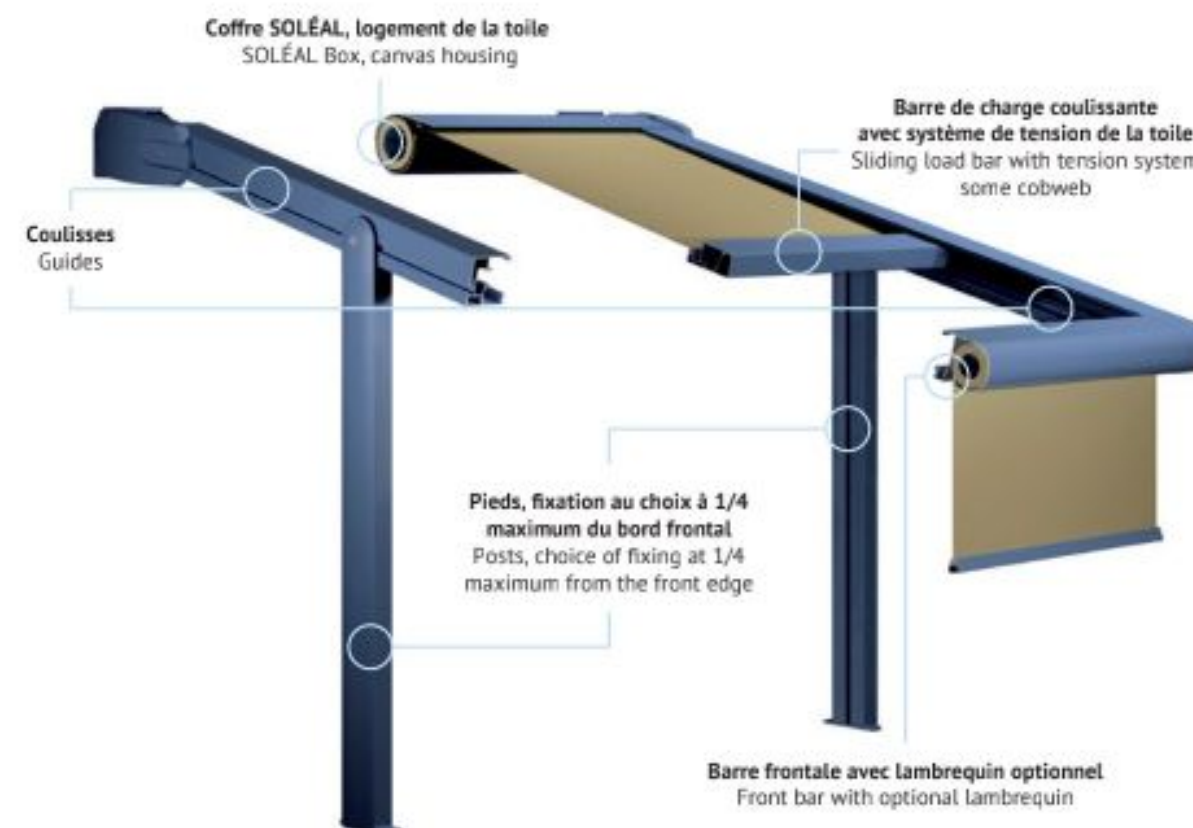



PERGOLA BIOCLIMATIQUE  
PERGOLA BIOCLIMATIC

# SUNCONTROL III

## Caractéristiques | Characteristics

- |   |  |
|---|--|
| <ul style="list-style-type: none"> <li>- Existe en adossé et autoportant</li> <li>- Poteau 154x154mm</li> <li>- Poutre gouttière 150x260mm</li> <li>- Lame 211mm double parois</li> <li>- Automatisation à vis sans fin caché</li> <li>- Aluminium thermolaqué Qualicoat / Qualimarine / Qualanod</li> <li>- Platine de fixation au sol</li> <li>- Led intégrées en périphérie</li> <li>- Boîtier de commande invisible avec télécommande et Application mobile (Android et Apple's IOS)</li> <li>- Option d'agrandissement des gouttières</li> </ul> | <ul style="list-style-type: none"> <li>- Available as lean to and freestanding</li> <li>- Posts 154x154mm</li> <li>- Gutter beam 150x260mm</li> <li>- Double walled slats 211mm</li> <li>- Hidden worm-screw automation</li> <li>- Powder coated aluminum Qualicoat / Qualimarine / Qualanod</li> <li>- Floor mounting plate</li> <li>- Peripheral build-in LEDs</li> <li>- invisible control box controled by remote control and smartphone app (Android and Apple's IOS)</li> <li>- Enlargement of gutters optional</li> </ul> |
|---|--|



<p><b>Résistance au VENT</b> Resistance to WIND</p> <p><b>C6</b> (101,61km/h)</p>	<p><b>Perméabilité à l'EAU</b> Permeability to WATER</p> <p><b>2L</b> (m<sup>3</sup> x min)</p>	<p><b>Charge de NEIGE</b> SNOW Load</p> <p><b>90</b> kg/m<sup>2</sup></p>
<p><b>CE</b></p> <p>Certifié ENAC - Laboratoire ENSATEC - CE NB 1668 n° de organisme notifié Classement - VENT C6 EN 13561</p> <p>Certified ENAC - Laboratory ENSATEC - CE NB 1668 notified entity number Ranking - WIND C6 EN 13561</p>		

**Lame orientable renforcée**  
Reinforced slat swivelable



**Gouttière**  
Rain gutter



**Gouttière TITAN**  
Rain gutter TITAN



**Poteau**  
Posts



**Platine au sol**  
Floor Plate

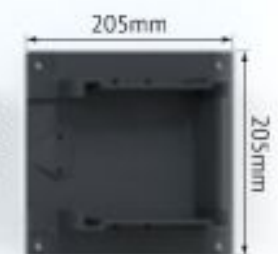

PERGOLA BIOCLIMATIQUE  
 PERGOLA BIOCLIMATIC

## SUNCONTROL III

### OPTION SUSPENDUE

### Caractéristiques | Characteristics

- Poutre gouttière 150x260mm
  - Lame 211mm double parois
  - Automatisme à vis sans fin caché
  - Aluminium thermolaqué Qualicoat / Qualimarine / Qualanod
  - Led intégrées en périphérie
  - Boîtier de commande invisible avec télécommande et Application mobile (Android et Apple's IOS)
  - Option d'agrandissement des gouttières
- Gutter beam 150x260mm
  - Double walled slats 211mm
  - Hidden worm-screw automation
  - Powder coated aluminum Qualicoat / Qualimarine / Qualanod
  - Peripheral build-in LEDs
  - Invisible control box controled by remote control and smartphone app (Android and Apple's IOS)
  - Enlargement of gutters optional

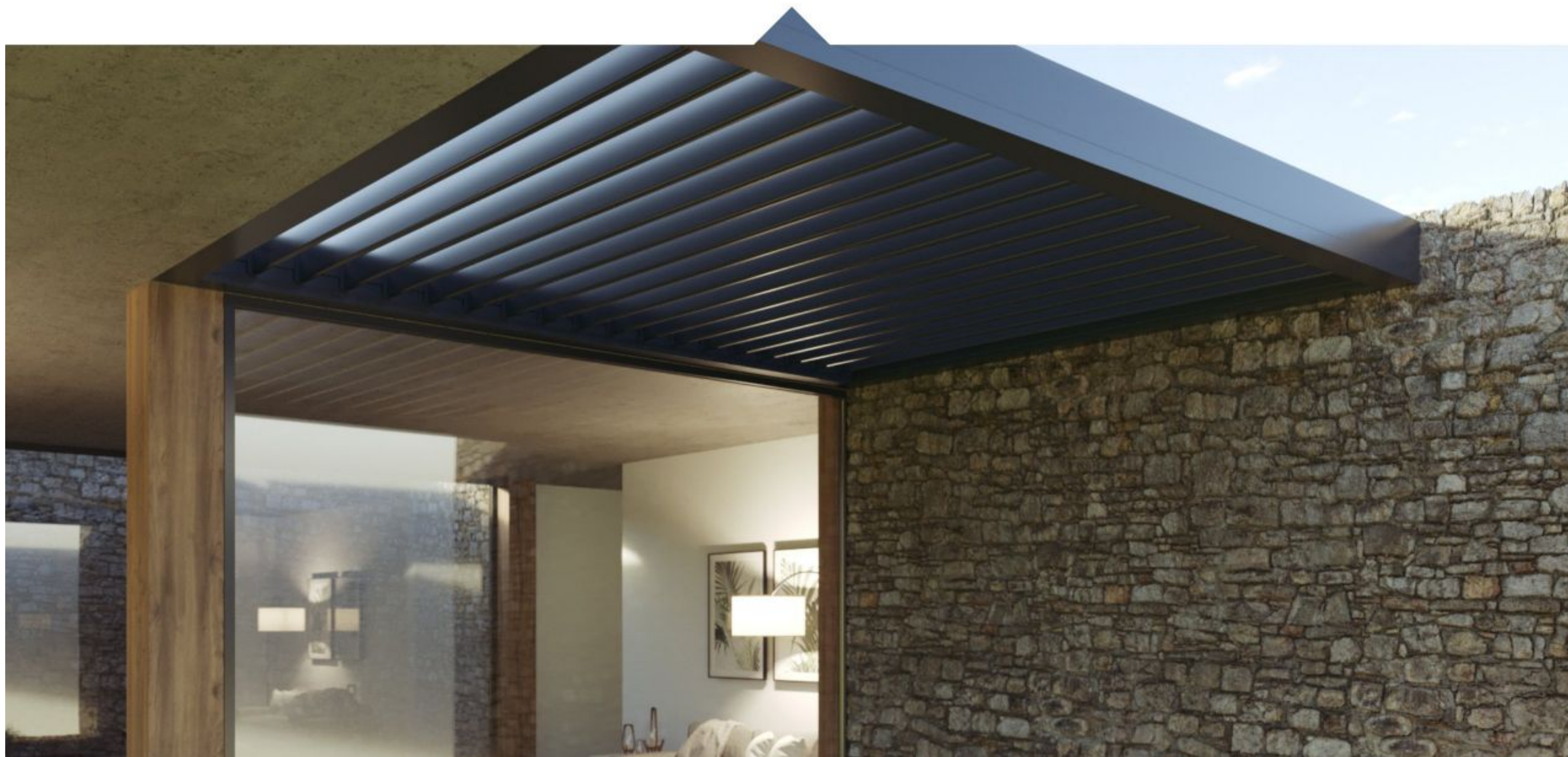





PERGOLA BIOCLIMATIQUE  
PERGOLA BIOCLIMATIC

## SUNCONTROL III OPTION TITAN

### Caractéristiques | Characteristics

- Existe en adossé et autoportant
  - Poteau 154x154mm
  - Poutre gouttière 150x350mm
  - Lame 211mm double parois
  - Automatisme à vis sans fin caché
  - Aluminium thermolaqué Qualicoat / Qualimarine / Qualanod
  - Platine de fixation au sol
  - Led intégrées en périphérie
  - Boîtier de commande invisible avec télécommande et Application mobile (Android et Apple's IOS)
  - Option d'agrandissement des gouttières
- Available as lean to and freestanding
  - Posts 154x154mm
  - Gutter beam 150x350mm
  - Double walled slats 211mm
  - Hidden worm-screw automation
  - Powder coated aluminum Qualicoat / Qualimarine / Qualanod
  - Floor mounting plate
  - Peripheral build-in LEDs
  - invisible control box controled by remote control and smartphone app (Android and Apple's IOS)
  - Enlargement of gutters optional



PERGOLA BIOCLIMATIQUE  
PERGOLA BIOCLIMATIC

# SUNCONTROL III TITAN, POTEAU DÉPORTÉ

## Caractéristiques | Characteristics

- |  |  |
|--|--|
| <ul style="list-style-type: none"> <li>- Existe seulement en adossé</li> <li>- Poteau 154x154mm</li> <li>- Poutre gouttière 150x350mm</li> <li>- Lame 211mm double parois</li> <li>- Automatisation à vis sans fin caché</li> <li>- Aluminium thermolaqué Qualicoat / Qualimarine / Qualanod</li> <li>- Platine de fixation au sol</li> <li>- Led intégrées en périphérie</li> <li>- Boîtier de commande invisible avec télécommande et Application mobile (Android et Apple's IOS)</li> <li>- Option d'agrandissement des gouttières</li> </ul> | <ul style="list-style-type: none"> <li>- Available only as lean to</li> <li>- Posts 154x154mm</li> <li>- Gutter beam 150x350mm</li> <li>- Double walled slats 211mm</li> <li>- Hidden worm-screw automation</li> <li>- Powder coated aluminum Qualicoat / Qualimarine / Qualanod</li> <li>- Floor mounting plate</li> <li>- Peripheral build-in LEDs</li> <li>- invisible control box controled by remote control and smartphone app (Android and Apple's IOS)</li> <li>- Enlargement of gutters optional</li> </ul> |
|--|--|

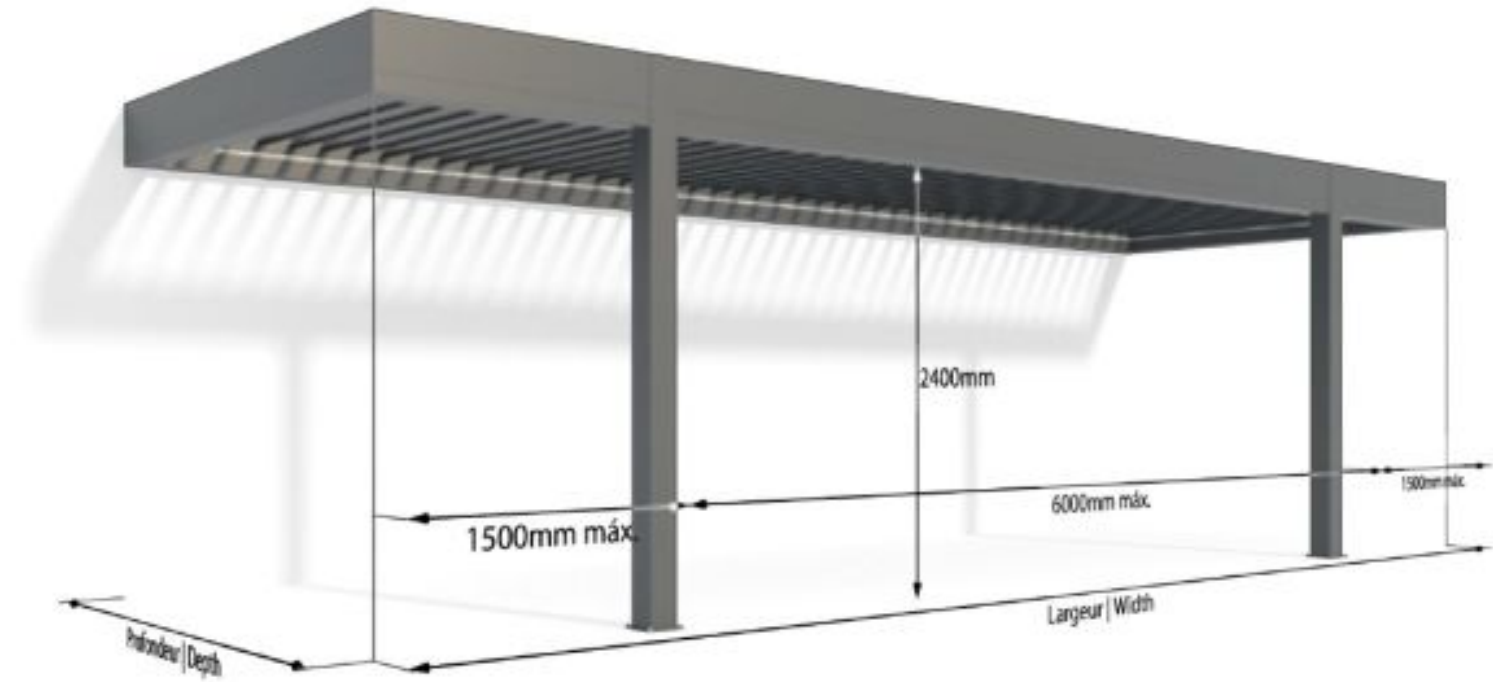

ADOSSÉE, FAÇADE  
LEAN TO, FRONT

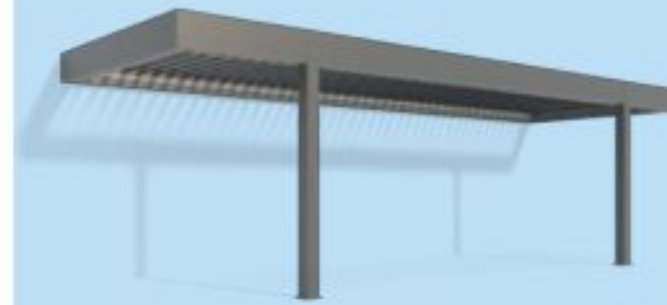

ADOSSÉE, PIGNON  
LEAN TO, SIDE

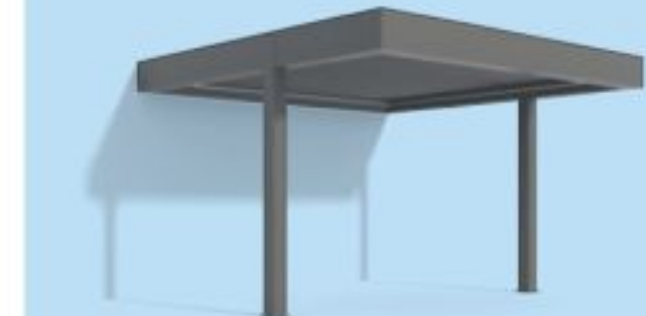

<p><b>Résistance au VENT</b> Resistance to WIND</p> <p><b>C6</b> (101,61km/h)</p>	<p><b>Perméabilité à l'EAU</b> Permeability to WATER</p> <p><b>2L</b> (m<sup>2</sup> x min)</p>	<p><b>Charge de NEIGE</b> SNOW Load</p> <p><b>90</b> Kg/m<sup>2</sup></p>
<div style="display: flex; align-items: center; justify-content: center;"> <div style="font-size: 0.8em; line-height: 1.2;"> <p>Certifié ENAC - Laboratoire ENSATEC - CE NB 1668 n° de organisme notifié Classement - VENT C6 EN 13561</p> <p>Certified ENAC - Laboratory ENSATEC - CE NB 1668 notified entity number Ranking - WIND C6 EN 13561</p> </div> </div>		

**Lame orientable renforcée**  
Reinforced slat swivelable



**Gouttière**  
Rain gutter



**Poteau**  
Posts



**Platine au sol**  
Floor Plate





PERGOLA BIOCLIMATIQUE  
PERGOLA BIOCLIMATIC



## SUNCONTROL III ARCH

### Caractéristiques | Characteristics

- |  |   |
|--|---|
| <ul style="list-style-type: none"> <li>- Existe en adossé et autoportant</li> <li>- Poteau 154x154mm</li> <li>- Poutre gouttière 150x260mm</li> <li>- Lame 211mm double parois</li> <li>- Automatisation à vis sans fin caché</li> <li>- Aluminium thermolaqué Qualicoat / Qualmarine / Qualanod</li> <li>- Platine de fixation au sol</li> <li>- Led intégrées en périphérie</li> <li>- Boîtier de commande invisible avec télécommande et Application mobile (📱Android et 🍏Apple's IOS)</li> </ul> | <ul style="list-style-type: none"> <li>- Available as lean to and freestanding</li> <li>- Posts 154x154mm</li> <li>- Gutter beam 150x260mm</li> <li>- Double walled slats 211mm</li> <li>- Hidden worm-screw automation</li> <li>- Powder coated aluminum Qualicoat / Qualmarine / Qualanod</li> <li>- Floor mounting plate</li> <li>- Peripheral build-in LEDs</li> <li>- invisible control box controlled by remote control and smartphone app (📱Android and 🍏Apple's IOS)</li> </ul> |
|--|---|



**AUTOPORTÉE, STANDARD**  
FREE STANDING, STANDARD

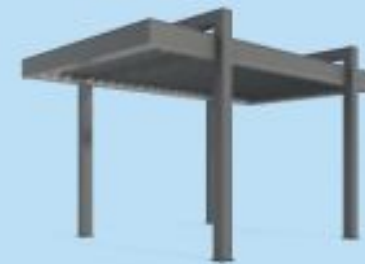

**ADOSSÉE, FAÇADE**  
LEAN TO, FRONT

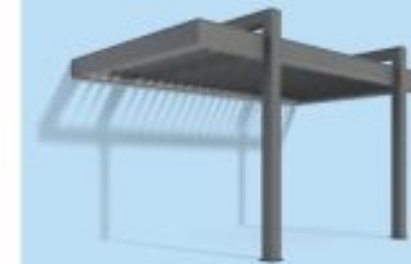

**ADOSSÉE, PIGNON**  
LEAN TO, SIDE



**Résistance au VENT**  
Resistance to WIND



**C6** (101,61km/h)

**Perméabilité à l'EAU**  
Permeability to WATER



**2L** (m² x min)

**Charge de NEIGE**  
SNOW Load



**90** kg/m²

Certifié ENAC - Laboratoire ENSATEC -  
CE NB 1668 n° de organisme notifié  
Classement - VENT C6  
EN 13561

Certified ENAC - Laboratory ENSATEC -  
CE NB 1668 notified entity number  
Ranking - WIND C6  
EN 13561

**Lame orientable renforcée**  
Reinforced slat swivelable



**Gouttière**  
Rain gutter



**Poteau**  
Posts

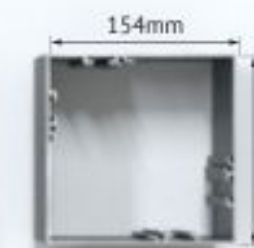

**Platine au sol**  
Floor Plate

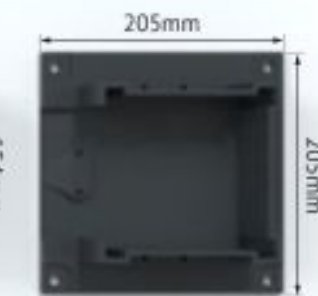



PERGOLA BIOCLIMATIQUE  
PERGOLA BIOCLIMATIC

## SUNNYCONTROL II

### Caractéristiques | Characteristics

- |  |   |
|--|---|
| <ul style="list-style-type: none"> <li>- Existe en adossé et autoportant</li> <li>- Poteau 100x100mm</li> <li>- Poutre gouttière 137x100mm</li> <li>- Aluminium thermolaqué Qualicoat / Qualimarine / Qualanod</li> <li>- Lame simple parois 212mm</li> <li>- Automatisation à vis sans fin visible</li> <li>- Platine de fixation au sol</li> <li>- Led intégrées sur deux cotés</li> <li>- Vis de fixation fournies</li> <li>- Boîtier de commande visible avec télécommande et Application mobile (📱 Android et 🍏 Apple's IOS)</li> </ul> | <ul style="list-style-type: none"> <li>- Available as lean to and freestanding</li> <li>- Posts 100x100mm</li> <li>- Gutter beam 137x100mm</li> <li>- Powder coated aluminum Qualicoat / Qualimarine / Qualanod</li> <li>- Single walled slats 212mm</li> <li>- Worm-screw visible automation</li> <li>- Floor mounting plate</li> <li>- two sides build-in LEDs</li> <li>- Fixing screws provided</li> <li>- Visible control box controled by remote control and smartphone app (📱 Android and 🍏 Apple's IOS)</li> </ul> |
|--|---|



Résistance au VENT  
Resistance to WIND

**C4**



Certifié ENAC - Laboratoire ENSATEC -  
CE NB 1668 n° de organisme notifié  
Classement - WIND C4  
EN 13561

Certified ENAC - Laboratory ENSATEC -  
CE NB 1668 notified entity number  
Ranking - WIND C4  
EN 13561

Lame orientable  
Slats swivelable



Gouttière  
Rain gutter



Poteau  
Posts



Platine au sol  
Floor Plate

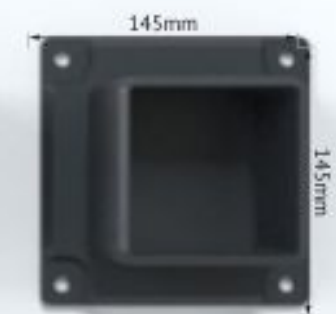







**PERGOLA BIOCLIMATIQUE**  
 PERGOLA BIOCLIMATIC  
**EASY UP**

**Caractéristiques | Characteristics**

- |  |  |
|--|--|
| <ul style="list-style-type: none"> <li>- Existe en adossé et autoportant</li> <li>- Poteau 100x100mm</li> <li>- Poutre gouttière 171x147mm</li> <li>- Aluminium thermolaqué Qualicoat / Qualimarine / Qualanod</li> <li>- Lame simple parois 212mm</li> <li>- Automatisme à vis sans fin invisible</li> <li>- Platine de fixation au sol</li> <li>- Led intégrées en le 4 cotés</li> <li>- Vis de fixation fournies</li> <li>- Boîtier de commande invisible avec télécommande et Application mobile (Android et Apple's IOS)</li> </ul> | <ul style="list-style-type: none"> <li>- Available as lean to and freestanding</li> <li>- Posts 100x100mm</li> <li>- Gutter beam 137x100mm</li> <li>- Powder coated aluminum Qualicoat / Qualimarine / Qualanod</li> <li>- Single walled slats 212mm</li> <li>- Covered worm-screw automation</li> <li>- Floor mounting plate</li> <li>- four sided build-in LEDs</li> <li>- Fixing screws provided</li> <li>- Invisible control box controled by remote control and smartphone app (Android and Apple's IOS)</li> </ul> |
|--|--|

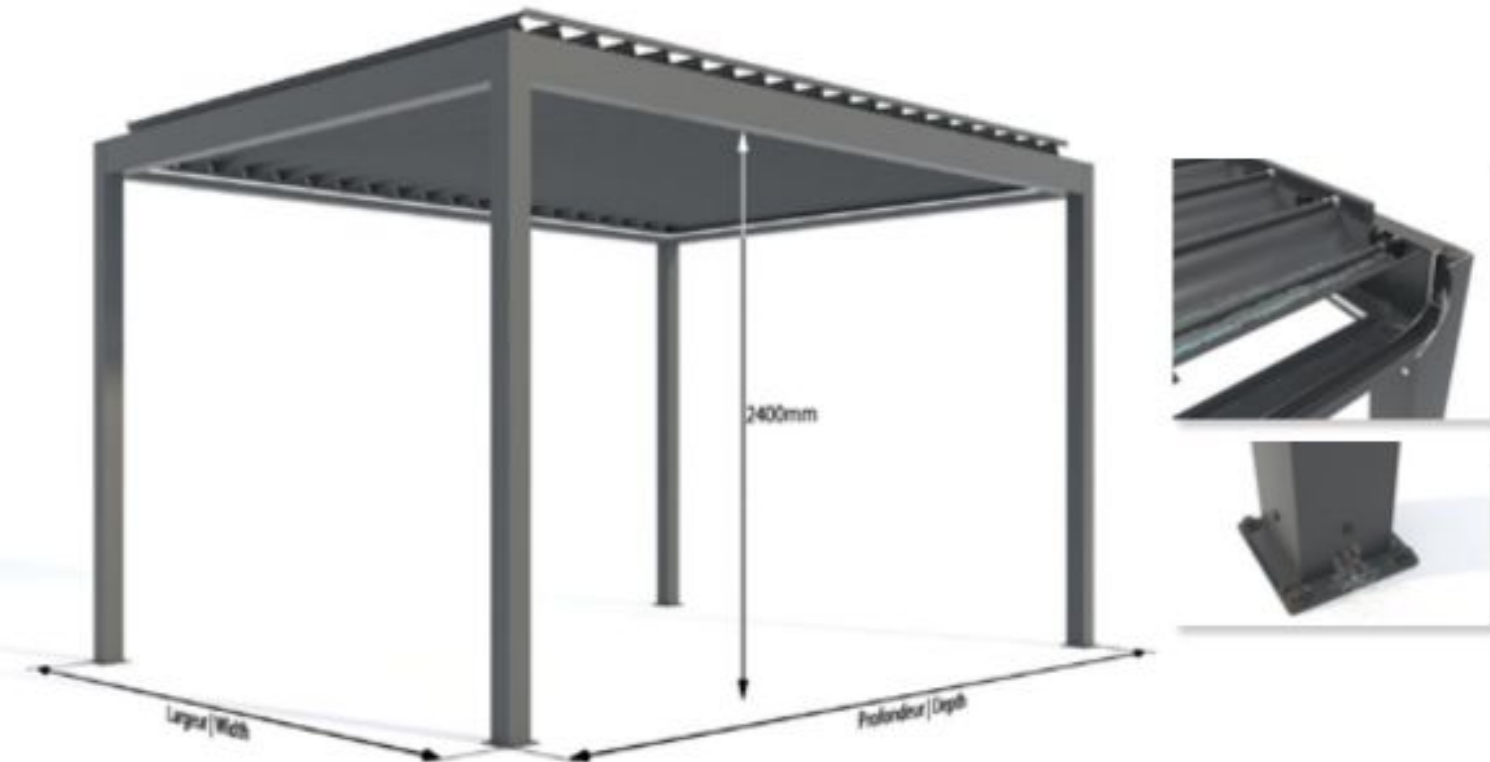

**Résistance au VENT**  
Resistance to WIND

C4

Certifié ENAC - Laboratoire ENSATEC - CE NB 1668 n° de organisme notifié  
 Classement - VENT C4  
 EN 13561

Certified ENAC - Laboratory ENSATEC - CE NB 1668 notified entity number  
 Ranking - WIND C4  
 EN 13561

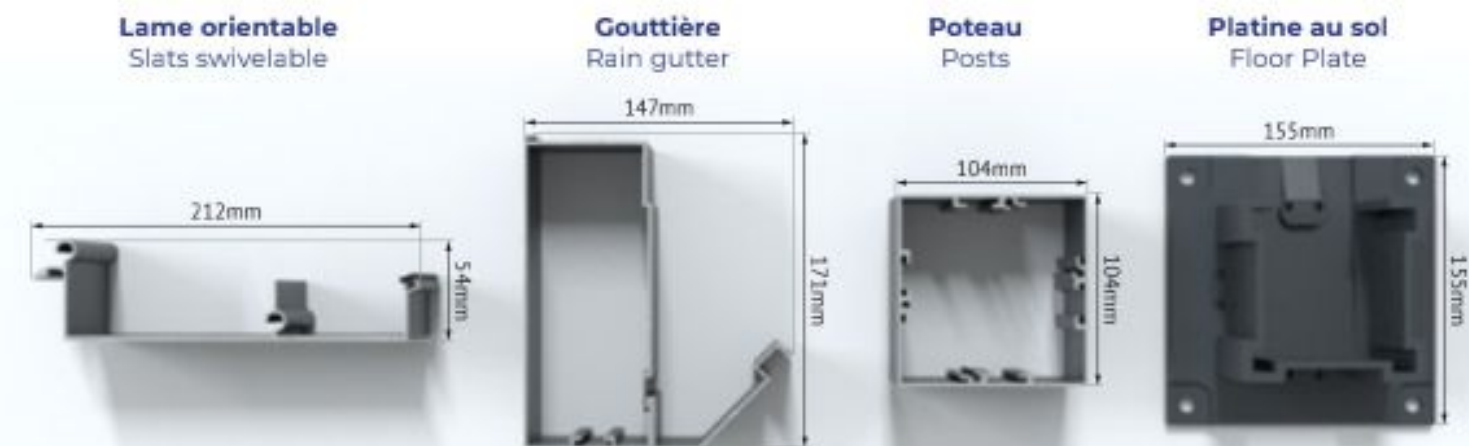



# STORE VERTICAL

## VERTICAL BLIND

### Caractéristiques | Characteristics

- Store vertical avec caisson et coulisse aluminium
  - Laquage label Qualicoat / Qualimarine / Qualanod
  - Axe en acier galvanisé
  - Lame finale avec joint epdm
  - Coulisse extrudée avec joint brosse intégrée
  - Motorisation NFI et récepteur radio avec sa télécommande multicanaux
  - Aluminium 100% recyclable
  - Toile polyester, PVC microperforé blanc ou gris anthracite
- Vertical blind with casing and aluminium rails
  - Aluminum lacquered Qualicoat/Qualimarine/Qualanod
  - Galvanized steel shaft
  - Final slat with EPDM seal
  - Guide rails extruded with integrated brush seals
  - Motorization NFI with radio control and own multi-channel remote control
  - 100% recyclable aluminum
  - Polyester fabric, PVC microperforated white or grey anthracite

### Caractéristiques du Toile | Characteristics of the fabric

	Specifications   Specifications	Méthode   Method
Épaisseur   Thickness	0,56 mm	
Masse totale   Total mass	350 ± 30 g/m <sup>2</sup>	EN ISO 2286-2
Masse du Support   Carrying Weight	130 ± 10 g/m <sup>2</sup>	EN ISO 2286-2
Charge de Rupture   Rupture Load	L: 40 daN/50mm ; T: 30 daN/50mm	EN ISO 1421
Resistance à la Coupure   Cut Resistance	L: 40 daN ; T: 30 daN	DIN 53363
Solidité de la couleur à la lumière   Colour Fastness to Light	min 6	EN ISO 105-B02
Perméabilité moyenne à l'air   Average Permeability to Air	3600 l/m <sup>2</sup> /s	NP EN ISO 9237
Transmission moyenne à la lumière   Average Light Transmission	24	SF 600 Plus Epectrofotometre SF 600 Plus Spektralphotometer
Comportement au feu   Burning Behaviour	< 100 mm/min	DIN 75200
Air Ouvert   Air Opening	23 %	Intérieure   Interior

Toile Gris  
Cloth Grey

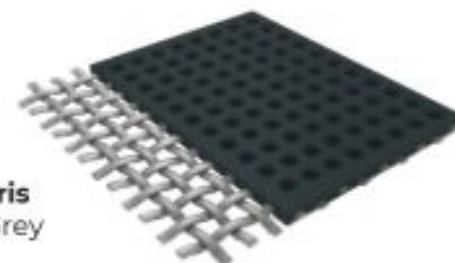

Toile Blanc  
Cloth White

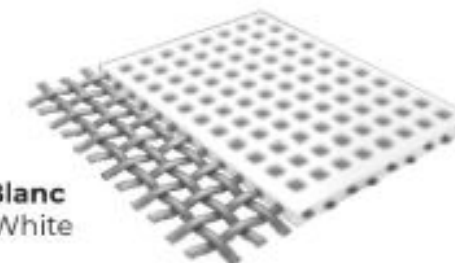



## STORE VERTICAL ZIP VERTICAL BLIND ZIP

### Caractéristiques | Characteristics

- Système élégant spécialement conçu pour que le tissu ne glisse pas hors des guides, grâce à sa fermeture,
- Adapté aux extérieurs, balcons, façades et pergolas, sa fonction principale est de réduire la température et de couvrir les côtés des pergolas;
- Idéal pour les petites et grandes longueurs;
- Les guides incorporant une fermeture latérale maintiennent la toile plus stable et son fonctionnement plus précis, offrant ainsi une plus grande résistance au vent;
- Offre efficacité, robustesse, sécurité et fiabilité;
- Design simple et fonctionnelle;
- Réduction des prises d'air et de la luminosité;
- Étiquette Qualicoat / Qualimarine / Qualanod;
- Axe en acier galvanisé;
- Traverse finale avec poids intérieur pour faciliter la descente;
- Motorisation NFI et récepteur radio avec sa télécommande multicanaux;
- Aluminium 100% recyclable;
- Tissu en polyester, PVC microformé blanc ou gris anthracite.

- Elegant system specially designed so that the fabric does not slip out of the guides, thanks to its closure,
- Suitable for exteriors, balconies, facades and pergolas, its main function is to reduce the temperature and cover the sides of the pergolas;
- Ideal for short and long lengths;
- The guides incorporating a side closure keep the canvas more stable and its operation more precise, thus offering greater resistance to the wind;
- Offers efficiency, robustness, safety and reliability;
- Simple and functional design;
- Reduction of air intakes and luminosity;
- Qualicoat / Qualimarine / Qualanod label;
- Galvanized steel axis;
- Final crossbar with internal weight to facilitate the descent;
- NFI motorization and radio receiver with its multi-channel remote control;
- 100% recyclable aluminum;
- Polyester fabric, white or anthracite gray microformed PVC.







## RIDEAU DE VERRE GLASS CURTAIN

### Caractéristiques | Characteristics

- Les rideaux sont des panneaux de verre coulissants, l'idéal pour fermer votre terrasse, balcon, Pergola etc. Garder l'espace frais en été et chaud en hiver.
- Des lignes simples et modernes, sans interruption d'aluminium, qui font que les espaces semblent plus spacieux et accueillants.
- Installation simple et rapide, sans nécessité d'une structure très robuste, car le poids est entièrement dans le seuil.
- Composé d'un rail en aluminium de 100mm avec 4 canaux, qui permet jusqu'à 8 vantaux.
- Verre feuilleté 5.5<sup>2</sup>, collé sur un profilé inférieur de 20x84x1,5mm
- Coulissant à l'intérieur d'un profil supérieur en aluminium également avec 4 canaux de 100 mm.
- Rails latéraux en aluminium avec 25x25mm

- This curtains are sliding glass panels, ideal for closing your terrace, balcony, Pergola etc. They keep the temperature cool at summer and warm at winter.
- Simple and modern lines, without aluminum interruptions, which make the spaces seem bigger and welcoming.
- Simple and quick installation, without need for a very robust structure, since the weight is entirely in the threshold.
- Composed of a 100mm aluminum rail with 4 channels, which allows up to 8 leaves.
- Laminated glass 5.5<sup>2</sup>, glued on a lower profile of 20x84x1,5mm
- Sliding inside an upper aluminum profile also with 4 channels of 100 mm.
- Aluminum side rails with 25x25mm









## CLOISON DE CLAIRE VOIE PRIVACY SCREEN

---

### Caractéristiques | Characteristics

- Cloison en aluminium aux lignes modernes, pour l'intimité de votre espace sans avoir besoin du passage d'air
- Composé de feuilles de 80x15mm qui sont induites à l'intérieur des gouttières avec des fentes pour eux
- aluminum partition with modern lines, for the privacy of your space without needing the air passage
- Consisting of 80x15mm sheets that are induced inside gutters with slots for them





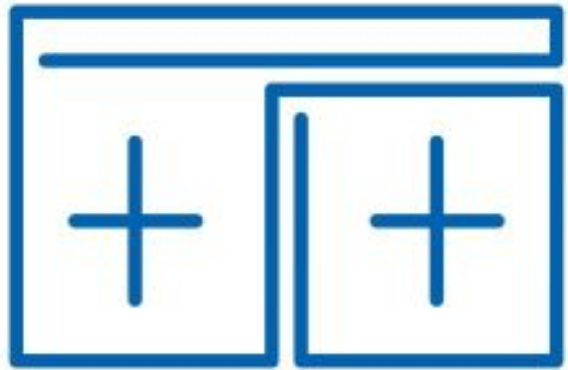

# VERANDA GLASS ROOM

**043 Veranda**  
Glass room

**047 Jardin d'Hiver Contemporain**  
Winter Garden Contemporain

**049 Jardin d'Hiver Classic**  
Winter Garden Classic

043



VERANDA | CLASS ROOM



WISMAR-NE  
VERTRIEBSGESELLSCHAFT



# VERANDA GLASS ROOM

## Caractéristiques | Characteristics

- Toiture pré-assemblé en atelier, photo et vidéo pour confirmation de la faisabilité et de la qualité des finitions
- Véritable toiture plate avec double toiture, panneau sandwich acier CE 100mm, laine de verre 50mm et panneau sandwich 30 mm avec renfort pente de 1 à 4 %
- Volet roulant lame de 50 mm, motorisation radio et télécommande multicanaux
- Eclairage Led périphérique intérieur et extérieur - gestion de luminosité, on/off et variation par radio
- Menuiserie RPTH CONSENSUS II, avec vitrage 4.20.4 warm edge, fe gaz argon, tri-rail, meneau minimaliste de 20mm avec renfort, fermeture jusqu'à 3 points avec option C
- Faitière/Sablière périphérique
- Chéneau et réhausse périphérique avec système d'équerre d'alignement
- Caisson de volet roulant périphérique
- Préparation des évacuation d'eau dans le chéneau, 2 sorties par angle en façade
- Visserie inox classe A2
- Conforme rt 2012
- Les profilés constituant la gamme véranda LUMINEAL titanium sont obtenus par filage à la presse, avec un alliage n°6060 AGTS elon normes NF A50710, NF EN 573.3, NF EN 7585.1, NF EN 755.2, NF EN 12020.1 et NF EN 12020.2
- Les profilés en alliage n°. 6060 qualité bâtiment dont les tolérances concernant le taux d'impureté est plus strict que la norme
- Véranda avec structure et charpente aluminium
- Les profilés sont labelisés qualicoat, qualimarine, qualanod, qualidécors et ont une garantie de 10 ans
- La garantie de la veranda selon nos cgv est garantie 10 ans
- Les vitrage sont labelisé CEKAL
- La véranda à été testé par un laboratoire indépendant ainsi par une étude DPE certifié
- La mise en œuvre répond aux exigences des règles professionnelles vérandas à structure aluminium du SNFA (juillet 2011)

- Roof pre-assembled in the workshop, photo and video to confirm the feasibility and quality of the finishes
- True flat roof with double roof, steel sandwich panel CE 100mm, glass wool 50mm and sandwich panel 30 mm with slope reinforcement from 1 to 4%
- Roller shutter with 50mm slat, radio motorization and multi-channel remote control
- Indoor and outdoor peripheral LED lighting - light management, on / off and dimming by radio
- RPTH CONSENSUS II joinery, with glazing 4.20.4 warm edge, fe argon gas, tri-rail, minimalist 20mm mullion with reinforcement, closing up to 3 points with option C
- Peripheral Rain gutter
- Gutter and peripheral riser with alignment bracket system
- Peripheral rolling shutter box
- Preparation of water evacuation in the gutter, 2 exits per facade angle
- Stainless steel screws class A2
- 2012 rt compliant
- The profiles constituting the LUMINEAL titanium veranda range are obtained by press spinning, with an alloy no. 6060 AGTS according to standards NF A50710, NF EN 573.3, NF EN 7585.1, NF EN 755.2, NF EN 12020.1 and NF EN 12020.2
- Alloy profiles no. 6060, building quality, the tolerances for which are higher than the standard
- Veranda with aluminum structure and frame
- The profiles are labeled qualicoat, qualimarine, qualanod, qualidécors, a 10 year warranty
- The veranda guarantee according to our terms and conditions is guaranteed 10 years
- The glazing is CEKAL certified
- The veranda has been tested by an independent laboratory and by a certified DPE study
- The implementation meets the requirements of the professional verandas with aluminum structure of the SNFA (July 2011)

# FICHE TECHNIQUE TECHNICAL SHEET

**Conductivité  
 THERMIQUE EXT.**  
 Ext. Thermal  
 CONDUCTIVITY



**0,707** w/mk

**Conductivité  
 THERMIQUE INT.**  
 Int. Thermal  
 CONDUCTIVITY



**0,276** w/mk

**Résistance  
 au VENT**  
 Resistance to  
 WIND



**C6** (101,61km/h)

**Perméabilité  
 à l'EAU**  
 Permeability to  
 WATER



**2L** (m² x min)

**Charge de NEIGE**  
 SNOW Load



**125** Kg/m²

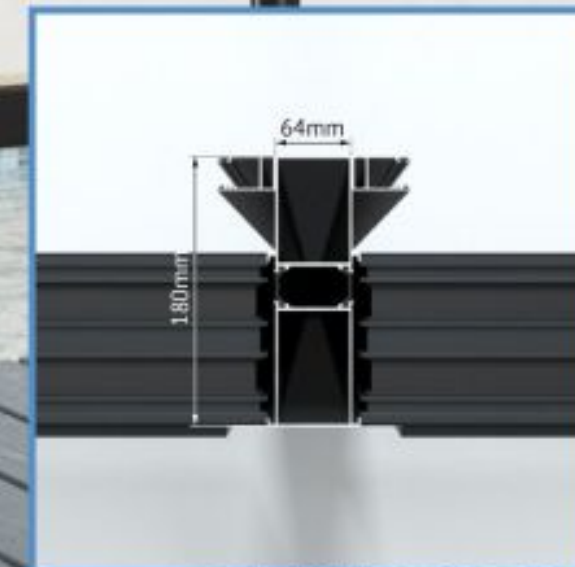
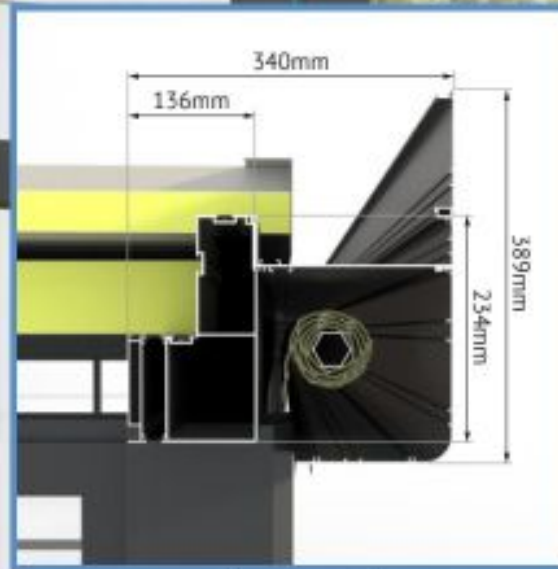

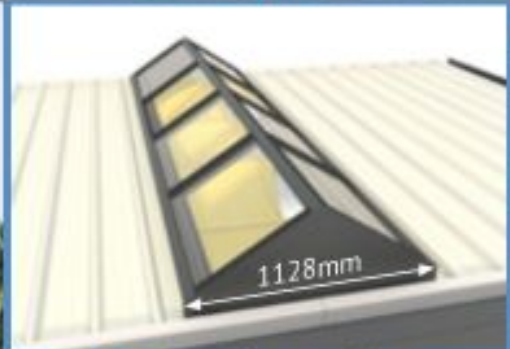

Puit de lumière avec Velum  
Skylight with shade cloth

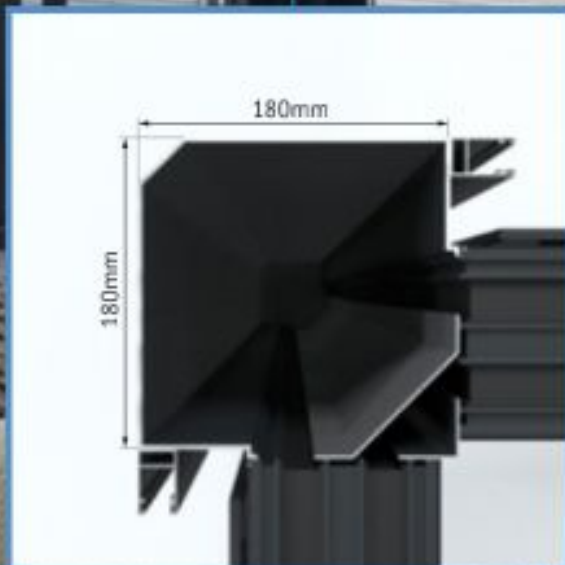









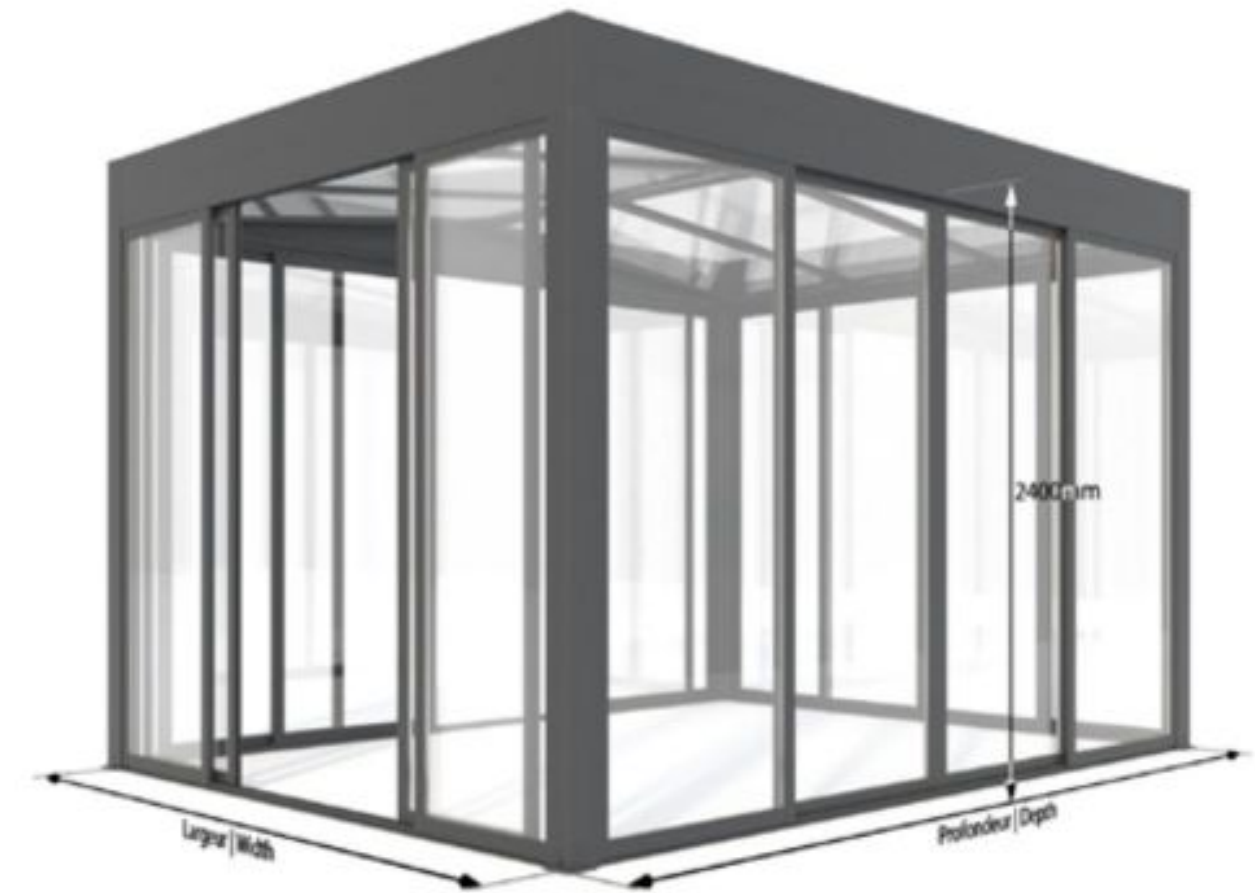

# JARDIN D'HIVER CONTEMPORAIN WINTER GARDEN CONTEMPORAIN

## Caractéristiques | Characteristics

- Existe en adossé seulement
  - Poteau 100x100mm et Poutre gouttière 288x100mm ou 438x100mm
  - Chevron 80x40mm
  - Inclinaison cachée mono pente
  - Aluminium thermolaqué Qualicoat / Qualimarine / Qualanod
  - Platine de fixation au sol
  - Panneau de polycarbonate opale 16mm traité anti UV avec obturateur poly, adhésif microperforé
- Available only as lean to
  - Posts 100x100mm and Gutter beam 288x100mm or 438x100mm
  - Rafters 80x40mm
  - Hidden one slope
  - Powder coated aluminum Qualicoat / Qualimarine / Qualanod
  - Floor mounting plate
  - Opal polycarbonate panel 16mm treated anti UV with poly shutter, microperforated adhesive



<p><b>Résistance au VENT</b> Resistance to WIND</p>  <p><b>C6</b> (101,61km/h)</p>	<p><b>Perméabilité à l'EAU</b> Permeability to WATER</p>  <p><b>2L</b> (m<sup>2</sup> x min)</p>	<p><b>Charge de NEIGE</b> SNOW Load</p>  <p><b>100</b> Kg/m<sup>2</sup></p>
<p><b>CE</b> Certifié ENAC - Laboratoire ENSATEC - CE NB 1668 n° de organisme notifié Classement - VENT C6 EN 13561</p> <p>Certified ENAC - Laboratory ENSATEC - CE NB 1668 notified entity number Ranking - WIND C6 EN 13561</p>		

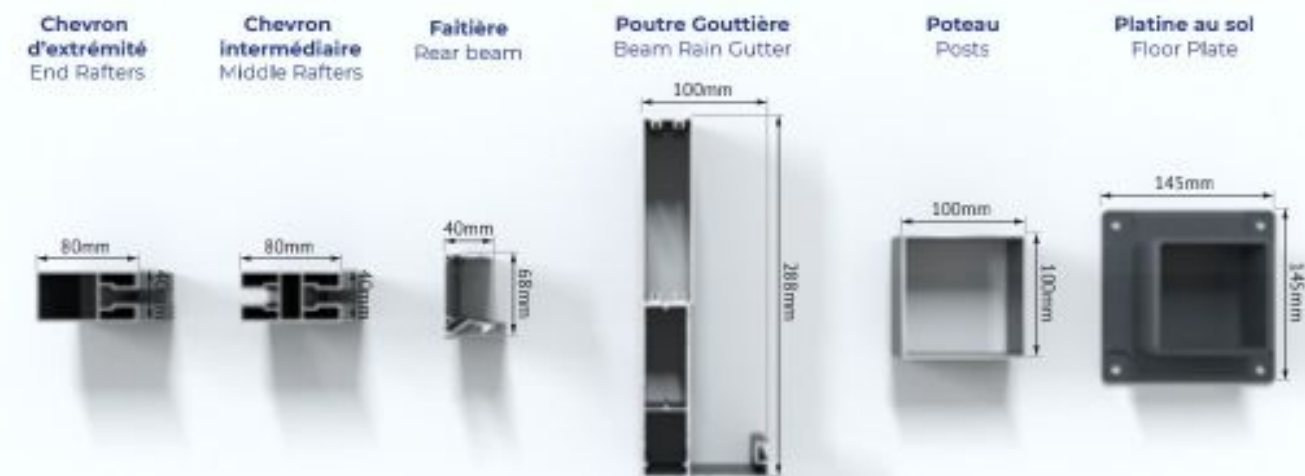





# JARDIN D'HIVER CLASSIC

## WINTER GARDEN CLASSIC

### Caractéristiques | Characteristics

- Poteau et faitière 120x64mm
- Gouttière 93x141mm
- Chevron 80x40mm
- Aluminium thermolaqué Qualicoat / Qualimarine / Qualanod
- Polycarbonate opale 16mm traité anti UV avec obturateur poly, adhésif microperforé, en option polycarbonate 10mm ou 32mm
- Platine de fixation au sol
- Vis de fixation fournies
- Fermeture aluminium sans rupture de pont thermique
- Vitrage 4.8.4

- Posts and beams 120x64mm
- Rain gutter 93x141mm
- Rafters 80x40mm
- Powder coated aluminum Qualicoat / Qualimarine / Qualanod
- Polycarbonate opal 16mm treated anti UV with poly shutter, adhesive microperforated, as optional 10mm or 32mm
- Floor mounting plate
- Fixing screws provided
- Aluminum windows without thermal break
- Glazing 4.8.4



Résistance au VENT  
Resistance to WIND

C5



Certifié ENAC - Laboratoire ENSATEC -  
CE NB 1668 n° de organisme notifié  
Classement - VENT C5  
EN 13561

Certified ENAC - Laboratory ENSATEC -  
CE NB 1668 notified entity number  
Ranking - WIND C5  
EN 13561

Chevron  
d'extrémité  
End Rafters

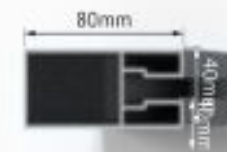

Chevron  
intermédiaire  
Middle Rafters



Gouttière  
Rain Gutter



Poteau  
Post



Platine au sol  
Floor Plate



051

STORE-BANNE | AWNING



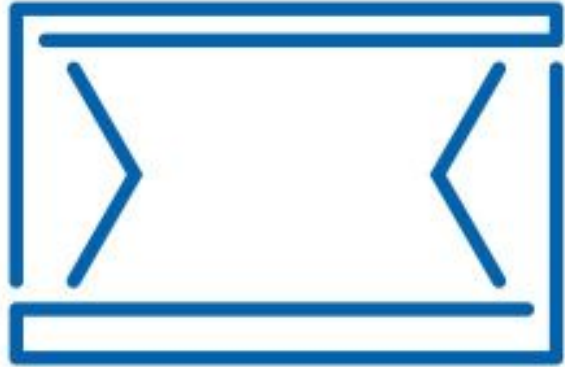

# STORE-BANNE

# AWNING

## Caractéristiques | Characteristics

- Store de grande projection
- Largeur maximale: 6050mm selon vos mesures
- Profondeur (projection) maximale: 3500mm
- Store autoportant avec 2 accroches rapides
- Pose façade
- Coffre fermé pour une protection de la toile optimale
- Toile acrylique teintée dans la masse 300 g/m<sup>2</sup> pour des couleurs éclatantes et durables
- Traitement imperméabilisant, double couture
- Réglage de la hauteur latérale des bras
- Griffe variateur permettant d'aligner la barre de charge au coffre et plot de guidage
- Résistance suivant la nouvelle norme européenne EN13561:2015
- Structure à l'épreuve du temps, profil extrudé aluminium et pièce fonderie
- Motorisation NFI et récepteur radio avec sa télécommande individuelle
- Transmission par 2 câbles
- Large projection awning
- Maximum width: 6050mm according to your measurements
- Maximum depth (projection): 3500mm
- Freestanding blind with 2 quick hooks
- Facade installation
- Closed chest for optimal canvas protection
- Acrylic canvas tinted in the mass 300 g / m<sup>2</sup> for vibrant and lasting colors
- Waterproofing treatment, double stitching
- Adjustment of the lateral height of the arms
- Variator claw to align the load bar to the boot and guide pad
- Resistance according to the new European standard EN13561: 2015
- Element proof structure, extruded aluminum profile and foundry part
- NFI motor and radio receiver with individual remote control
- Transmission by 2 cables

Résistance  
au VENT  
Resistance to  
WIND



C1 (32,13km/h)

- Résistance à la traction en N (Une en ISO 13934-1) : Ch/ 1400, Tr/ 950
- Allongement au point de rupture en % (Une en ISO 13934-1) : Ch/ 28, Tr/25
- Résistance au déchirement en N (Une en ISO 40404) : Ch/ 40, Tr/ 30
- Résistance des couleurs aux UV (Une en ISO 105B02) : 7 (très bonne)
- Résistance à la pénétration de l'eau cmH2O (Une en ISO 20811) : 30+ cm
- Poids : 300 g/m<sup>2</sup>

- Tensile strength in N (One as ISO 13934-1): Ch/ 1400, Tr/ 950
- Elongation at breaking point in % (One as ISO 13934-1): Ch/ 28, Tr/25
- Tear strength in N (One as ISO 40404): Ch/ 40, Tr/ 30
- Color fastness to UV (One as ISO 105B02): 7 (very good)
- Resistance to water penetration cmH2O (One as ISO 20811): 30+ cm
- Weight: 300g/m<sup>2</sup>

CE

EN13561:2015

## COLLECTION DE TOILES | CANVAS COLLECTION



\*Couleur indicative voir à échantillon | \*Indicative color see sample

# COLLECTION DE TOILES | CANVAS COLLECTION

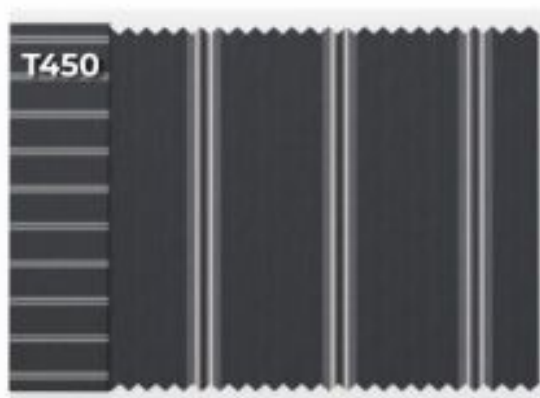
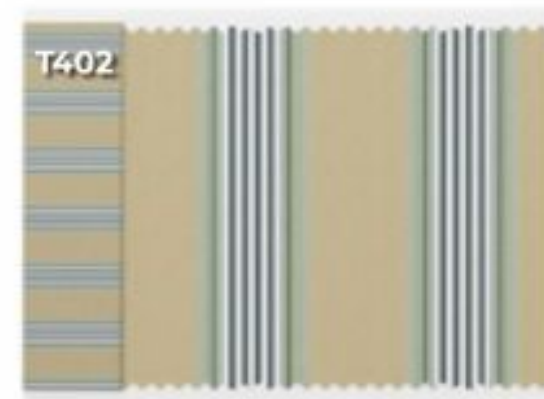
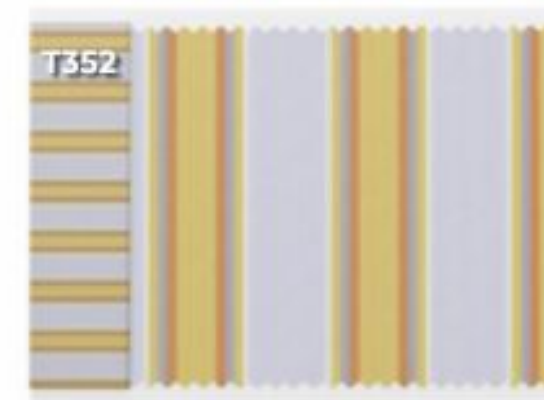
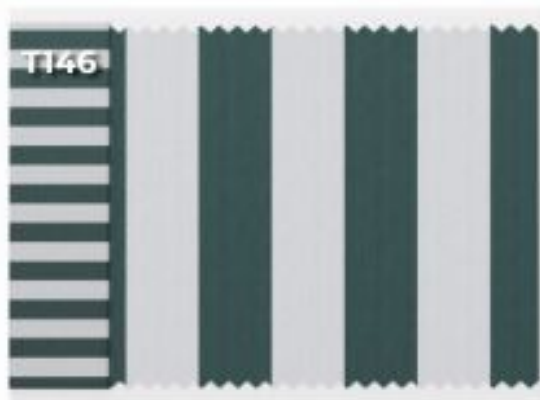
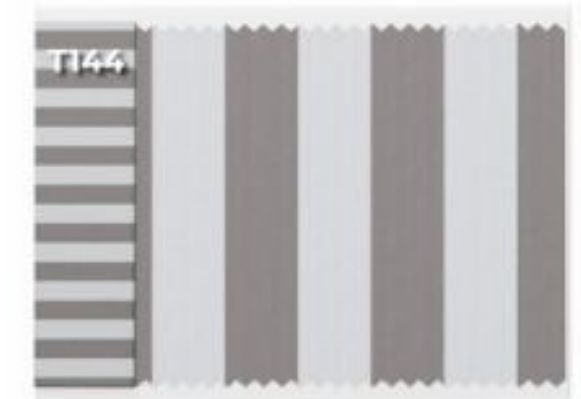
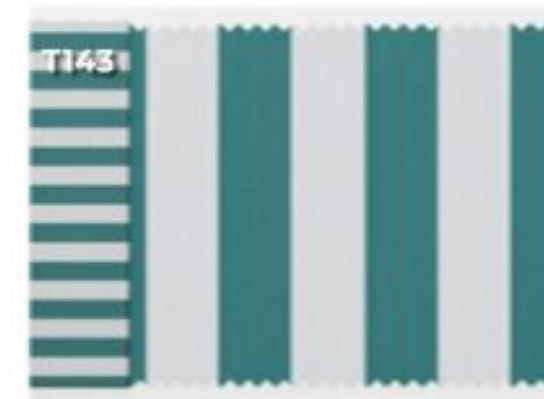
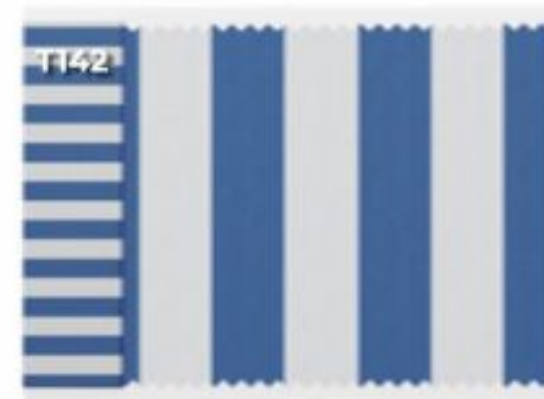
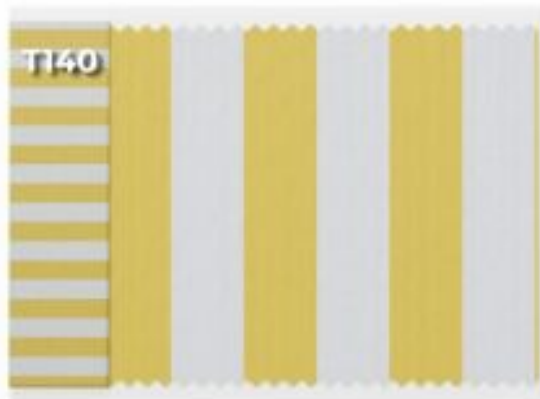

\*Couleur indicative voir à échantillon | \*Indicative color see sample



**Rua da Braziela, n°51 Fradelos  
4760 - 564 Vila Nova de Famalicão, Portugal**

**Tel.: (00 351) 252 412 734**  
**Tel. (fr): 06 25 57 24 36**  
**Fax: (00 351) 252 412 735**  
**Email: [commerce@nfi.pt](mailto:commerce@nfi.pt)**  
**Online: [www.nfi.pt](http://www.nfi.pt)**



**Wismar-NFI Vertriebs GmbH  
Robert- Bosch- Str. 2  
D- 68542 Heddesheim, Deutschland**

**Tel.: 06203-40440**  
**Fax.: 06203-404424**  
**E- mail: [info@wismar-nfi.de](mailto:info@wismar-nfi.de)**

 Tout le contenu, photos, textes et graphiques sont protégés par copyright. Vous ne pouvez pas sans le consentement écrit préalable de NFI - Nouvelles Fermetures International en tout ou en partie, être copié, modifié, reproduit ou publié.  
La société NFI - Nouvelles Fermetures International insiste sur le fait de vérifier régulièrement son image de marque.

 All contents, photos, texts and graphic arts are protected by copyright. They may be changed not without previous written approval of NFI - Nouvelles Fermetures International neither completely nor in extracts copied, be multiplied or be published.  
The company NFI - Nouvelles Fermetures International insists on verifying its trademark at any time.

 Sämtliche Inhalte, Fotos, Texte und Graphiken sind urheberrechtlich geschützt. Sie dürfen ohne vorherige schriftliche Genehmigung durch NFI - Nouvelles Fermetures International weder ganz noch auszugsweise kopiert, verändert, vervielfältigt oder veröffentlicht werden.  
Die Gesellschaft NFI - Nouvelles Fermetures International besteht darauf ihr Markenzeichen jederzeit zu überprüfen.

